

Service Manual

AV Control Stereo Receiver

Receiver

SA-G77

Simplified



Colour

(K) ... Black Type

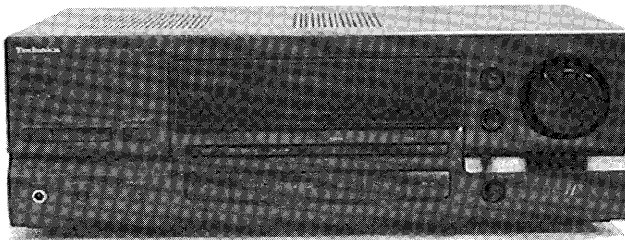

Area

Suffix for Model No.	Area	Colour
(PP)	U.S.A. and Canada	(K)

* Manufactured under license from Dolby Laboratories Licensing Corporation. Additionally licensed under one or more of the following patents: U.S. numbers 3,632,886, 3,746,792 and 3,959,590; Canadian numbers 1,004,603 and 1,037,877. "Dolby" and the double-D symbol are trade marks of Dolby Laboratories Licensing Corporation.

Please file and use this Service Manual together with the Service Manual for Model No. SA-G76 (PP) Order No. MD9602002C1.

Note : This Simplified Service Manual is provided to indicate the main difference between the original Model No. SA-G76 (PP) and the subsequent Model No. SA-G77 (PP).

CHANGES



■ SPECIFICATIONS

■ Amplifier Section

Rated minimum sine wave RMS power output
 40 Hz– 20kHz both channels driven
 0.9% total harmonic distortion 110W per channel (8Ω)
1kHz continuous power output both channels driven
 0.9% total harmonic distortion 115W per channel (8Ω)
Power output at the Dolby Pro Logic operation
 0.9% at 1kHz,
Front 2 x 100W (8Ω)
Center 100W (8Ω)
Surround 100W (8Ω)
 (Surround speakers' total impedance)

■ Amplifier Section

Rated minimum sine wave RMS power output
 40 Hz– 20kHz both channels driven
 0.9% total harmonic distortion 120W per channel (8Ω)
1kHz continuous power output both channels driven
 0.9% total harmonic distortion 125W per channel (8Ω)
Power output at the Dolby Pro Logic operation
 0.9% at 1kHz,
Front 2 x 110W (8Ω)
Center 110W (8Ω)
Surround 110W (8Ω)
 (Surround speakers' total impedance)

⚠ WARNING

This service information is designed for experienced repair technicians only and is not designed for use by the general public. It does not contain warnings or cautions to advise non-technical individuals of potential dangers in attempting to service a product. Products powered by electricity should be serviced or repaired only by experienced professional technicians. Any attempt to service or repair the product or products dealt with in this service information by anyone else could result in serious injury or death.

Notes :
 Specifications are subject to change without notice.
 Weight and dimensions shown are approximate.

© 1997 Matsushita Electronics (S) Pte. Ltd.
 All rights reserved. Unauthorized copying
 and distribution is a violation of law.

Technics®

Line up of Components

Unit	System Name	SC-S185PC-K	SC-S2800P-M	SC-S2850P-K
Electronics Block (Made in MAV)				
Amplifier (Made in MAV)		SA-G77PP-K	SA-G77PP-K	SA-G77PP-K
Graphic Equalizer (Made in MAV)			SH-GE50PP-K	SH-GE50PP-K
Electronics Block (Made in MESA)				
Cassette Deck (Made in MESA)		RS-TR180PP-K	RS-TR180PP-K	RS-TR180PP-K
CD Changer (Made in MESA)		SL-MC59PP-K	SL-MC59PP-K	SL-MC59PP-K
Accessories Box (Made in MESA)		SH-WA18PC-K	SH-WA28P-K	SH-WA28P-K
Front Speaker (Made in MEP)		SB-A28PP-K	SB-A28P-M	SB-A28PP-K
Speaker Block (Made in MEP)				
Center Speaker (Made in MEP)		SB-C938PP-K	SB-C938P-M	SB-C938PP-K
Surround Speaker (Made in MEP)		SB-S938PP-K	SB-S938P-M	SB-S938PP-K
Rack (Made in MEP)		SH-KS27PP-K	SH-KS27P-M	SH-KS27PP-K

Change In Replacement Parts List

Notes: * Mentioned in this parts list is only those different from Model No. RX-DT530 (EB).

* Important safety notice:

Components identified by  mark have special characteristics important for safety.

Furthermore, special parts which have purposes of fire-retardant (resistors), high-quality sound (capacitors), low noise (resistors), etc are used.

When replacing any of these components, be sure to use only manufacturer's specified parts shown in the parts list.

* [M] Indicates in the Remarks columns indicates parts supplied by MESA.

Ref. No.	Description	Change of Parts Number		Remarks
		SA-G76PP-K	SA-G77PP-K	
CABINET AND CHASSIS				
2	REAR PANEL	RGR0237B-A	RGR0237C-A [M]	
16	FRONT PANEL ASS'Y	RFKGSAG76PPK	RFKGSAG77PPK [M]	
INTEGRATED CIRCUITS				
IC401	IC, SELECTOR	TC9163N	TC9163AN [M]	
CONNECTORS				
CP771	CONNECTOR (FAN)	SJT3213	RJP2G4YA [M]	
JACKS				
JK406	RCA JACK		SJF3069-15N [M]	
PACKING MATERIALS				
P3	PACKING CASE	RPG2780	RPG3374 [M]	
RESISTORS				
R433	470 1/4W		ERDS2TJ471T [M]	
R434	470 1/4W		ERDS2TJ471T [M]	
R435	470 1/4W		ERDS2TJ471T [M]	
R436	470 1/4W		ERDS2TJ471T [M]	
R751	3.3M 1/2W	ERC12ZGK335D	ERC12UGK335D [M]	
CAPACITORS				
C433	100P 50V		ECBT1H101KB5 [M]	
C434	100P 50V		ECBT1H101KB5 [M]	
C435	100P 50V		ECBT1H101KB5 [M]	
C436	100P 50V		ECBT1H101KB5 [M]	

■ Printed Circuit Board
E MAIN P.C.B. (REP2332C-M)

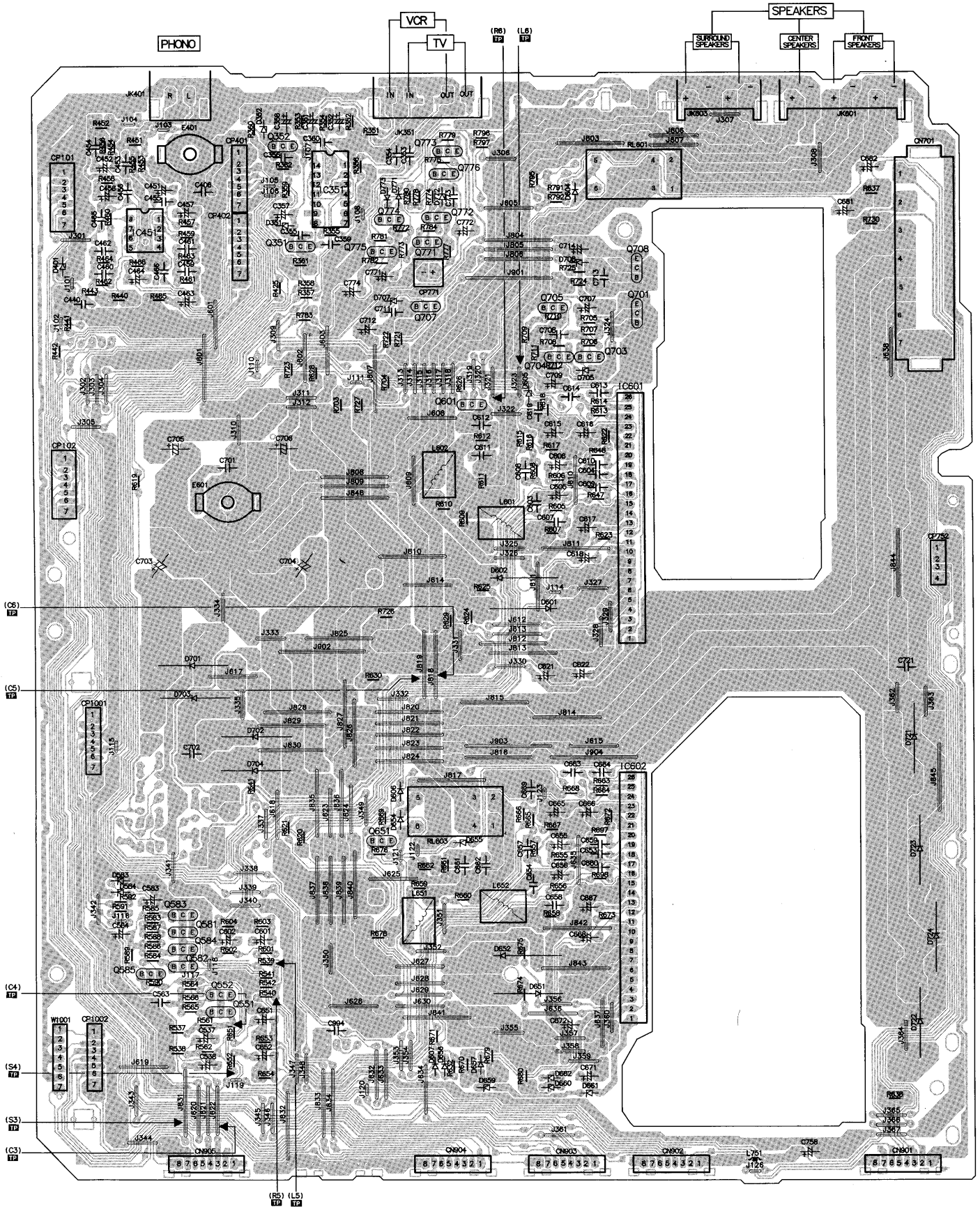

F POWER SUPPLY P.C.B. (REP2334C-P)

Note : Only part No. change for Power Supply P.C.B.

(REP2334A-P)
SA-G76PP-K



(REP2334C-P)
SA-G77PP-K

I IN/OUT TERMINAL P.C.B. (REP2332C-M)

Note : Only part No. change for Power Supply P.C.B.

(REP2332A-M)
SA-G76PP-K



(REP2332C-M)
SA-G77PP-K

G EQ/EXT TERMINAL P.C.B. (REP2332C-M)

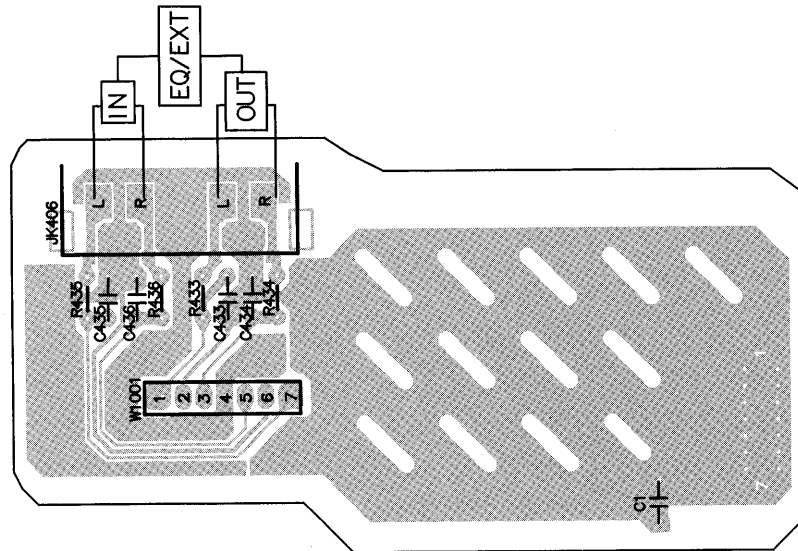

Schematic Diagram

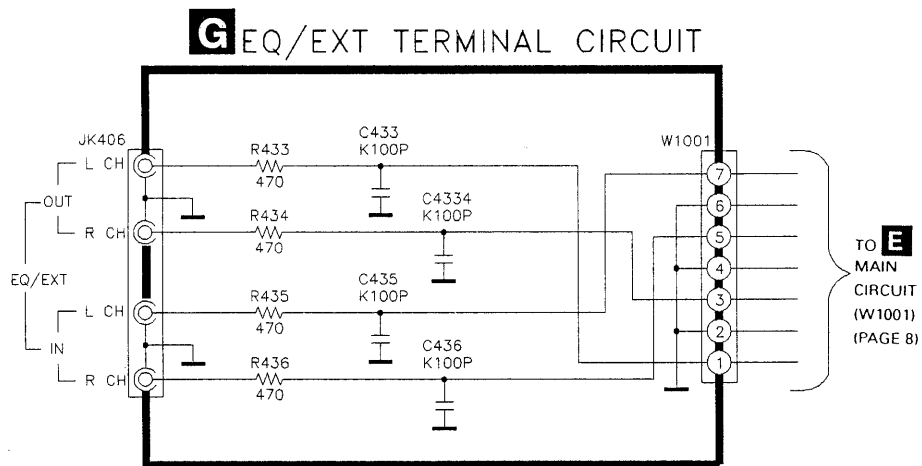

E MAIN CIRCUIT

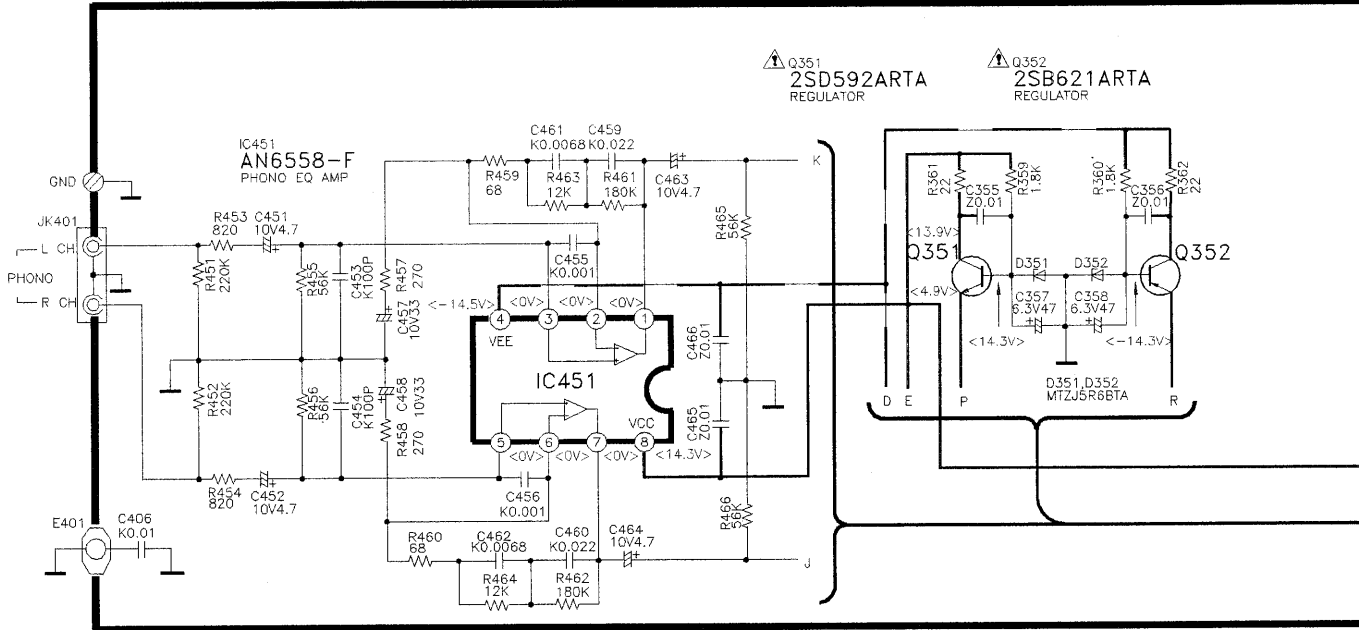

I IN/OUT TERMINAL CIRCUIT

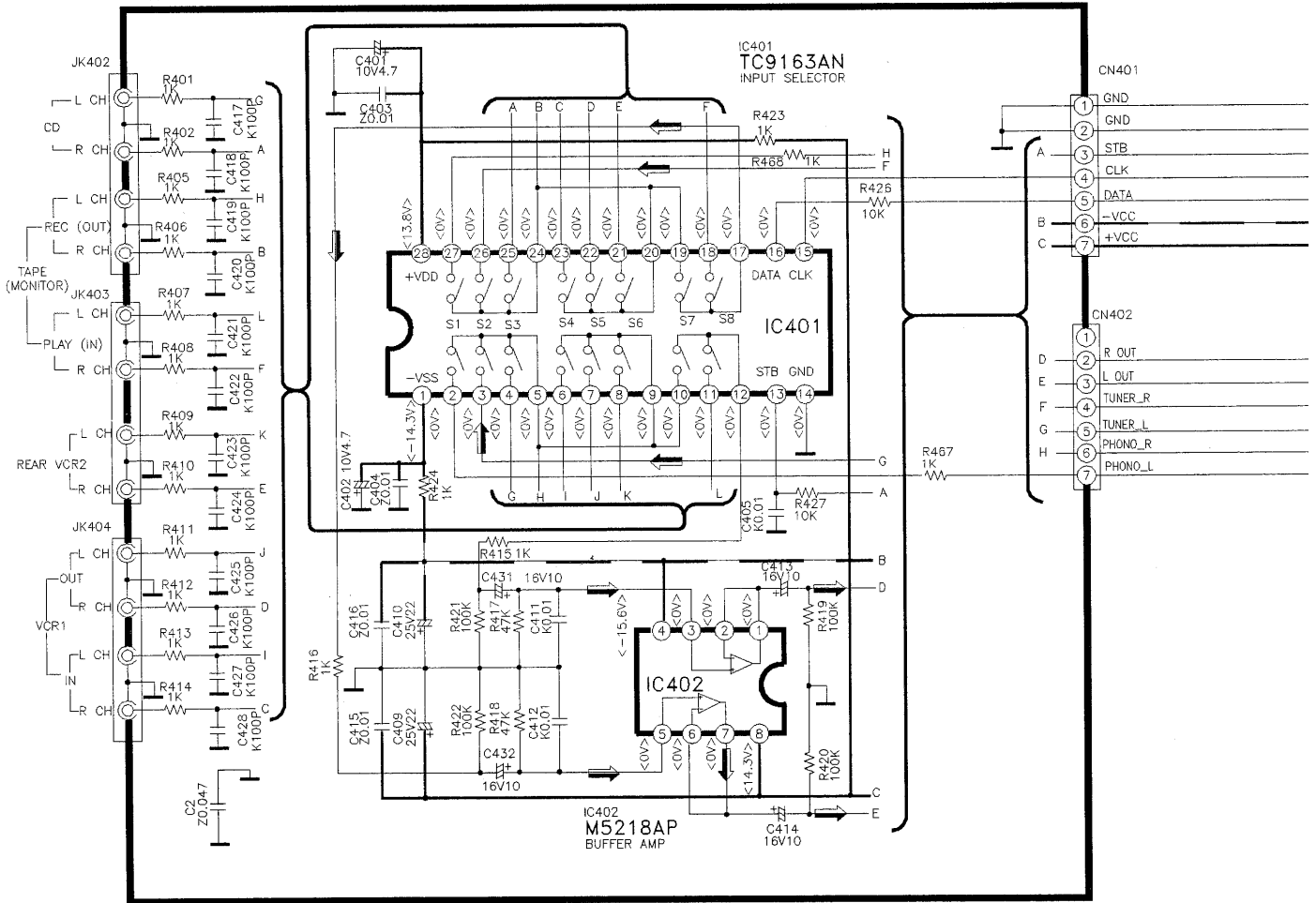

△ IC601
RSN3305-P
POWER AMP

Q601
UN4119TA
RELAY SWITCH

Q581, Q582
2SA1309ARTA
MUTING

Q583, Q584
2SC3311ARTA
MUTING

Q685
2SA1309ARTA
POWER LIMITER

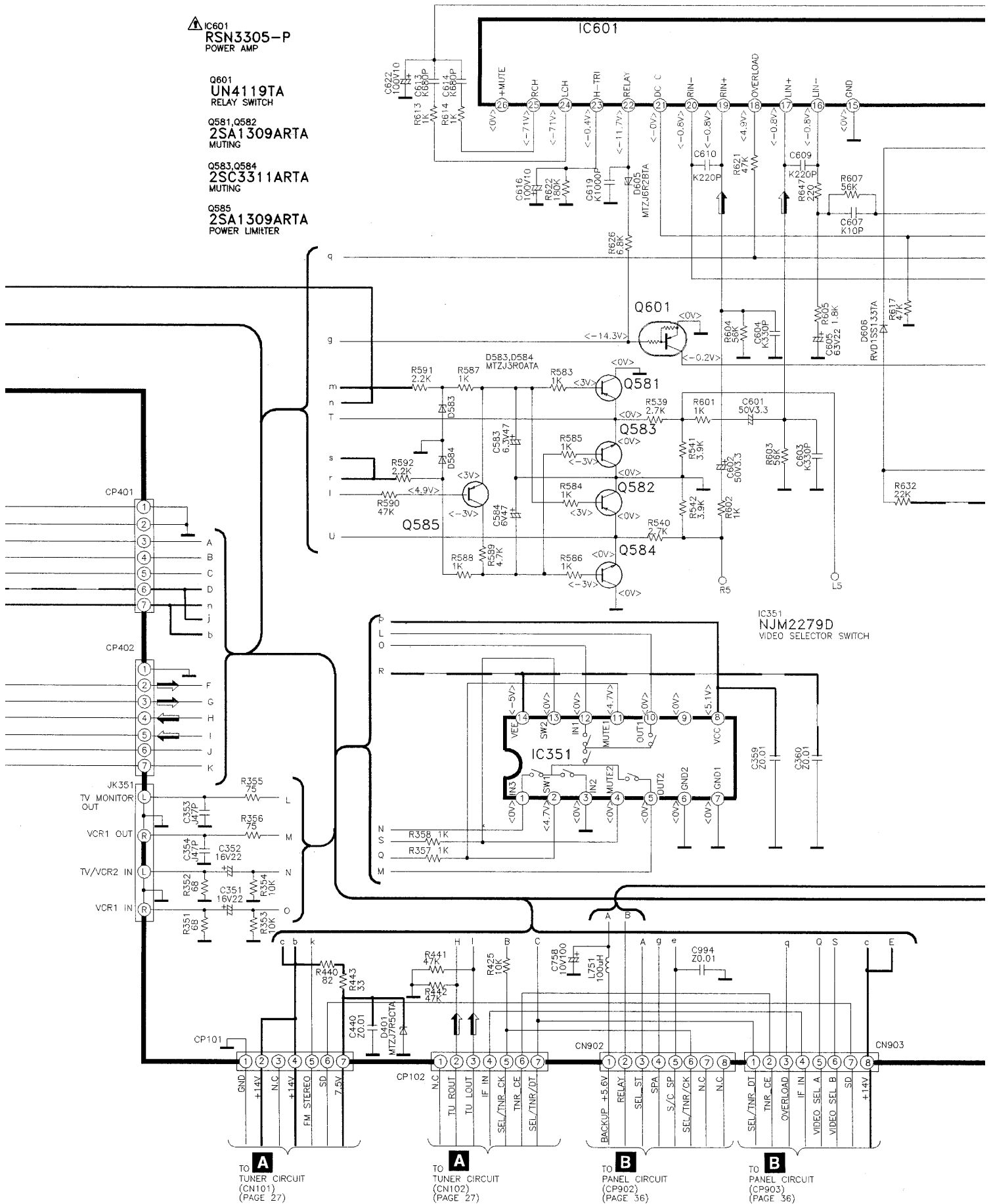

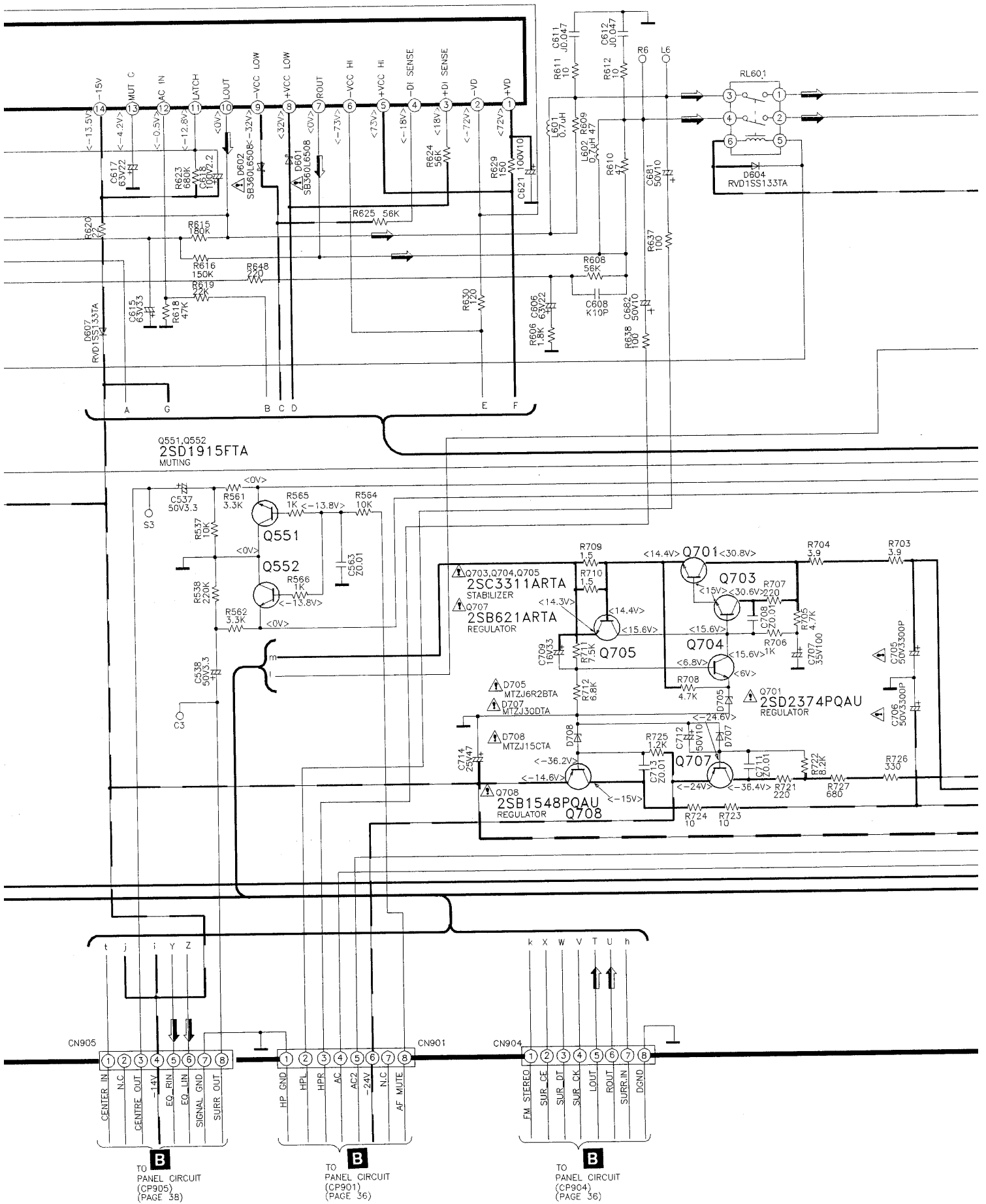

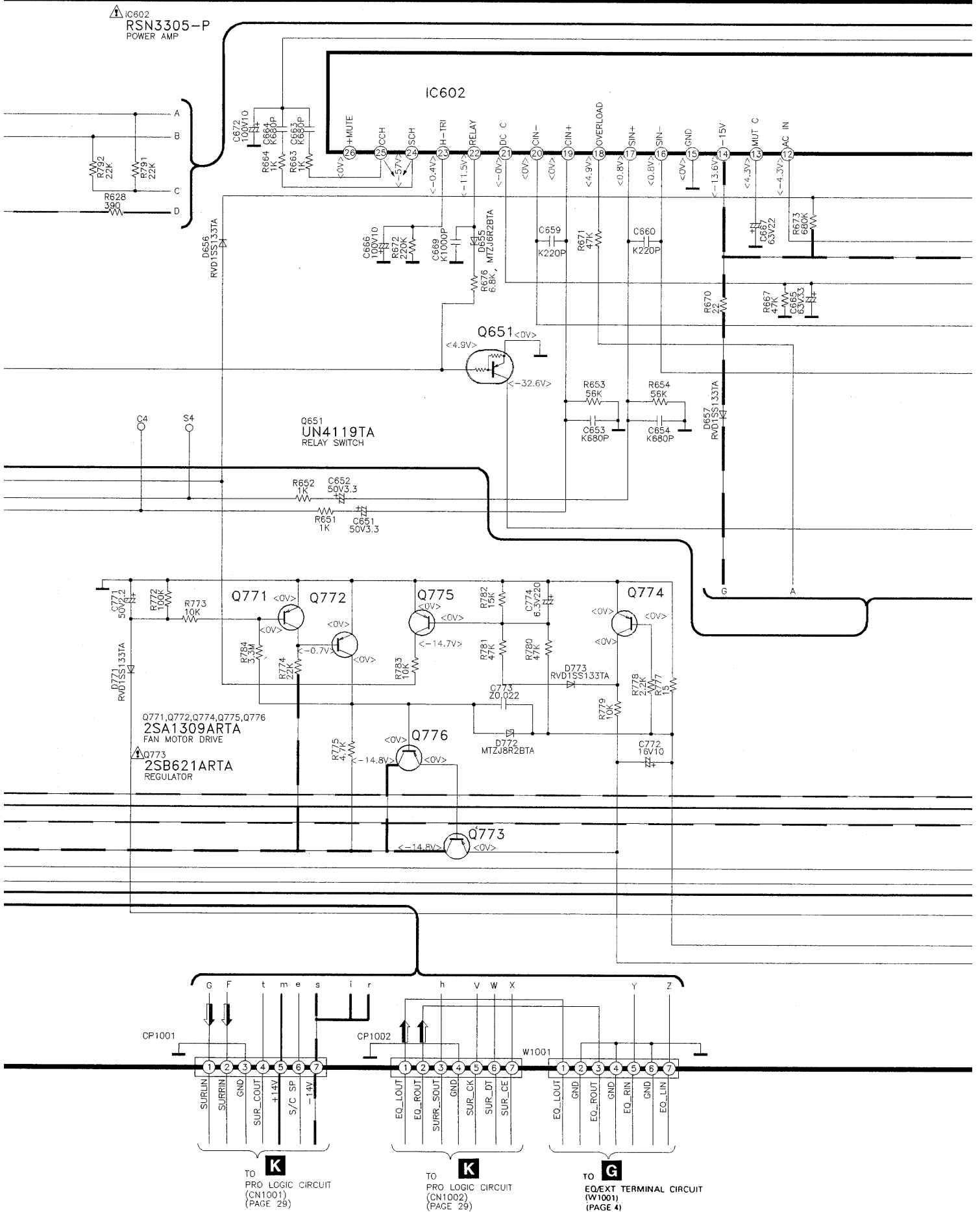

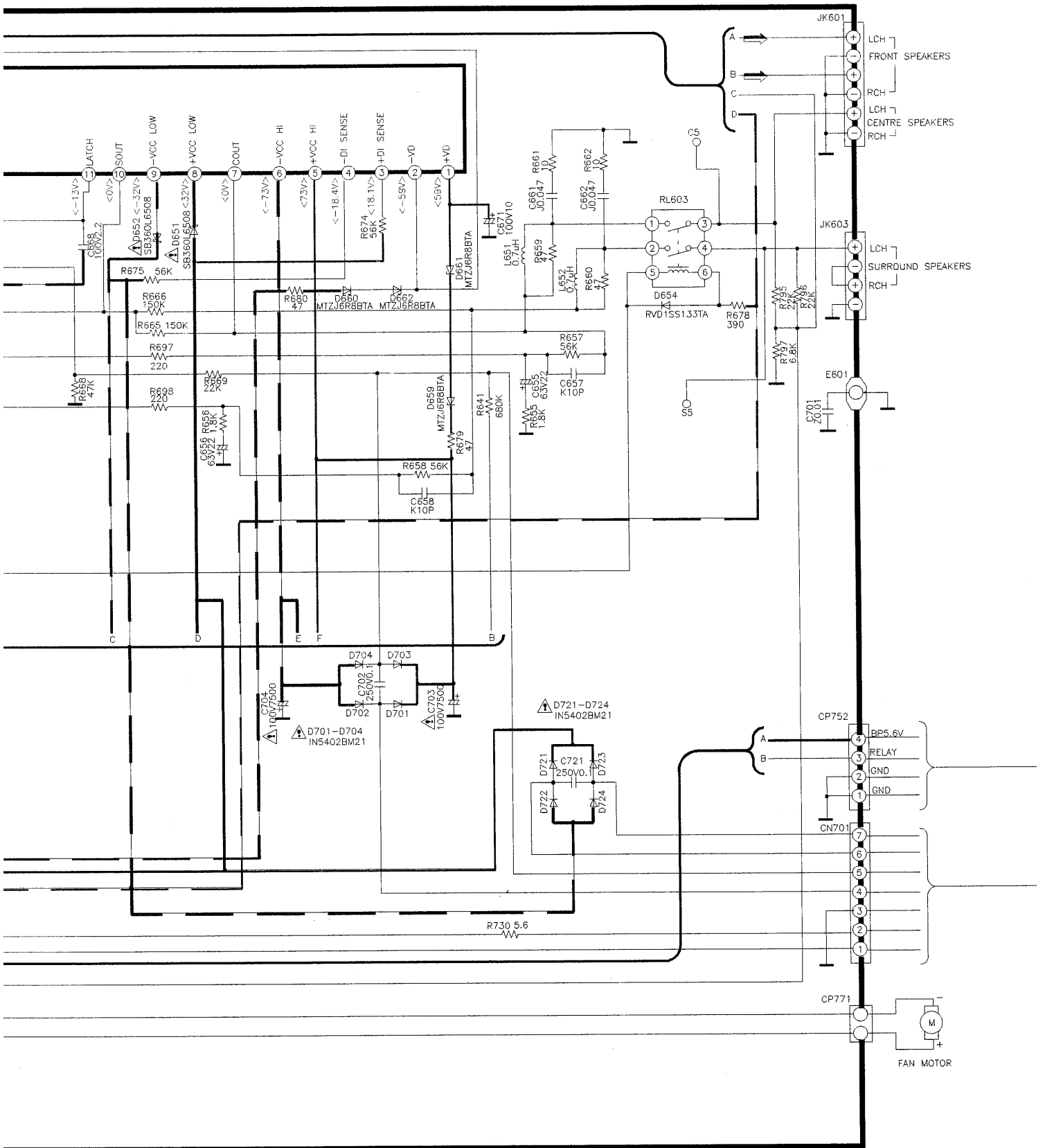

■ Wiring Connection Diagram

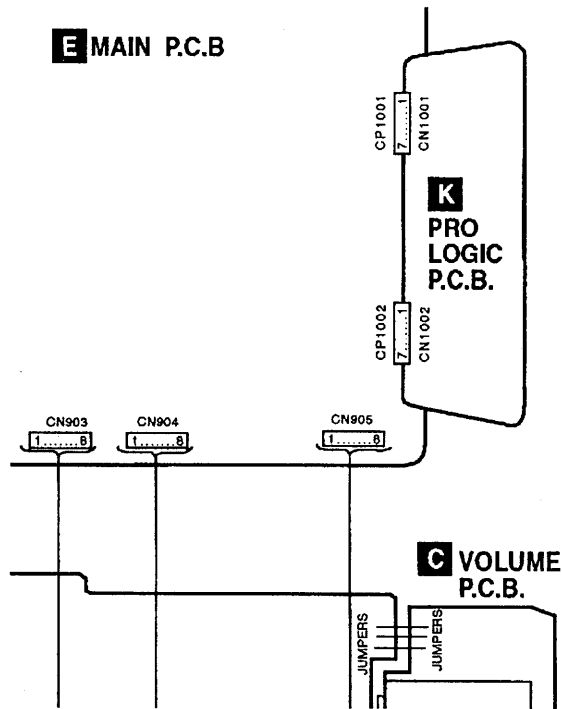

(SA-G76PP-K)

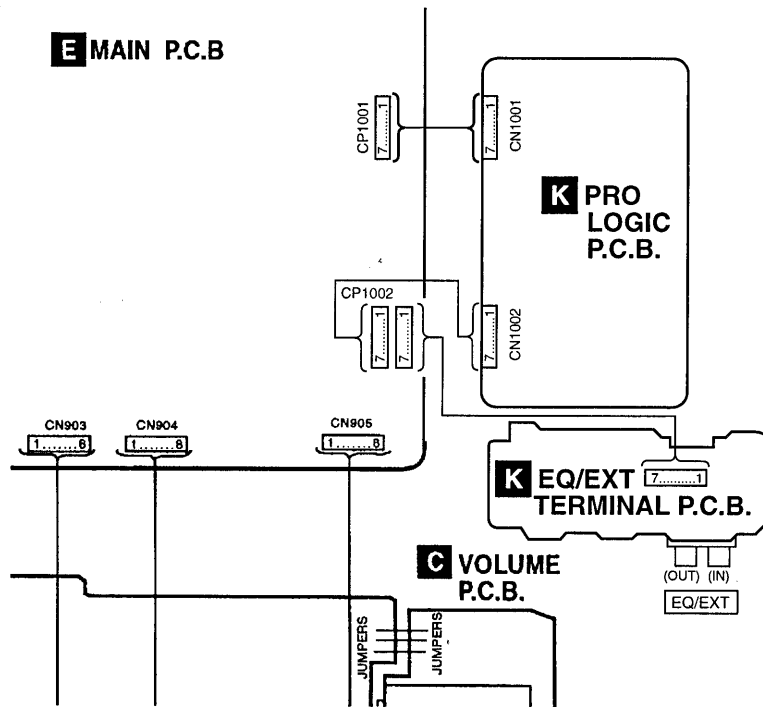

(SA-G77PP-K)

Cabinet Parts Location

